

INSTRUCTION MANUAL

for Installing

NO.1 PUTNAM ROLLING

LADDERS AND HARDWARE

PL.210, PL.230 (Top Guide Assemblies)
PL.270-S, PL.270-C (Bottom Wheel Assemblies)



Instruction Manual for No.1 Putnam Rolling Ladders and Hardware

Installation Tools Needed:

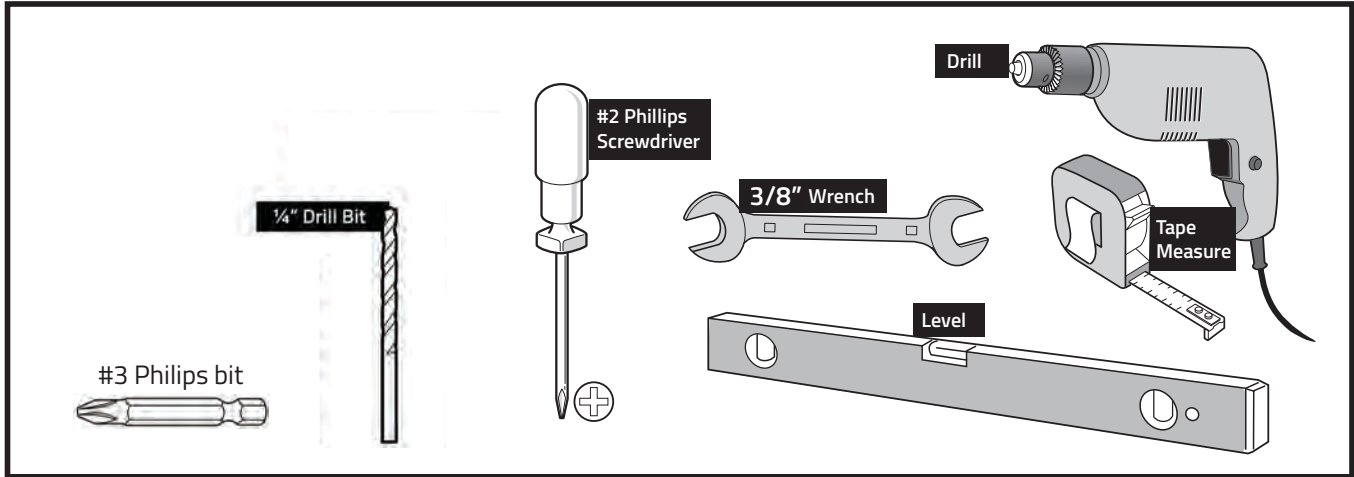

Hardware Kits vary. See Page 10 for different hardware components.

Step 1: Rail Installation

Special application notes/cautions:

- Leave at least 7" of clearance between the center of the rail and the ceiling, crown molding or other overhanging protrusions when the ladder is in the stored position (close to the wall/cabinet/bookshelf). In the climbing position, a minimum 3" clearance between the center of the rail and any upper cabinet doors is required to be able to open the upper cabinet doors (see figure 1).
- Do not mount rail brackets directly onto a drywall surface. Always mount these brackets to solid wood, pre-drilling the holes in the wood is advisable to avoid splitting the wood.
- Do not use rail brackets as a splice between 2 rails (instead, use the supplied wooden dowels for this purpose)
- Do not use hook-style ladder hardware with curved rails.

Figure 1

Top Ladder Clearance

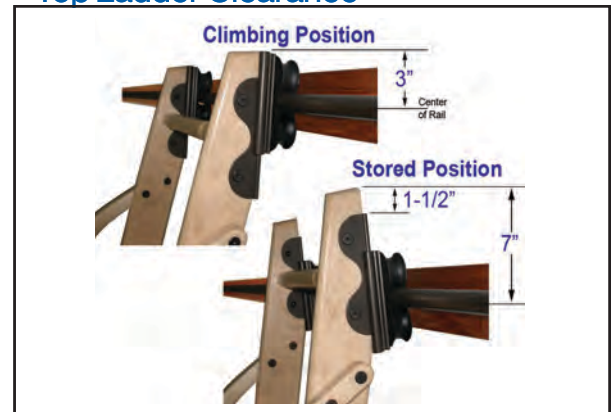

1. Establish the height where the center of the rail is to be installed, then mark the location where the mounting bracket will be located. Verify with a quality leveling device that the horizontal locations of the brackets are level and true.

Figure 2

2. Splice the sections of rails together using the supplied wooden dowels. Do not put rail brackets in the area where the splices will be located (see figure 2).

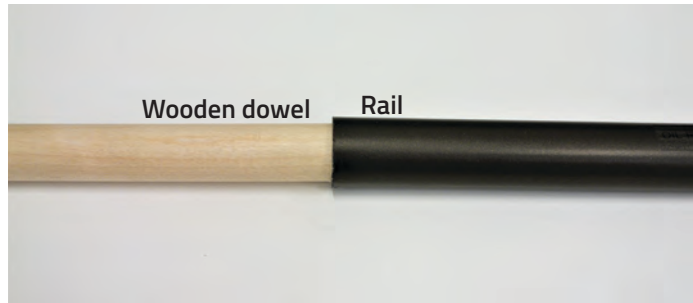

3. Install rail brackets
 - a. For vertical brackets (PL.14 series): Drive the brackets into the slotted rail and align them with the vertical uprights/stiles on the shelving unit. Mark the fastener locations and pre-drill the holes in the wood to avoid splitting. Secure the brackets using the supplied screws (be sure to use the tapped and threaded brackets for the ends of the rails, (see vertical brackets below).
 - b. For horizontal brackets (PL.27 series): Separate the bracket and fasten the back plate to the shelving unit or horizontal trim board in the desired location, no more than 36" from center to center (pre-drill the holes in the wood to avoid splitting). Drive the bracket fronts into the track and align with the mounted backs, then reassemble the brackets with the rail attached (use the left and right brackets with the attached end caps for the ends of the rails).

To install a PL.210 roller type ladder onto the rail when using the horizontal brackets:

 - *Separate one of the outside brackets with end cap attached.*
 - *Slide the front portion of the bracket off the rail.*
 - *Install ladder onto the rail and reinstall the end bracket.*

Vertical Brackets

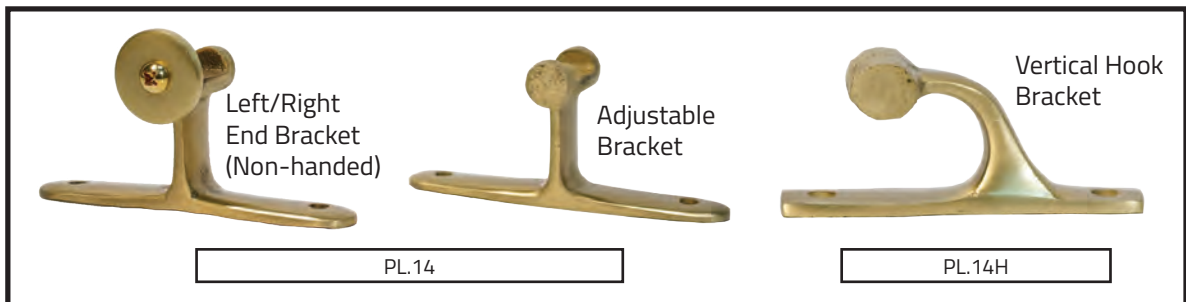

Horizontal Brackets

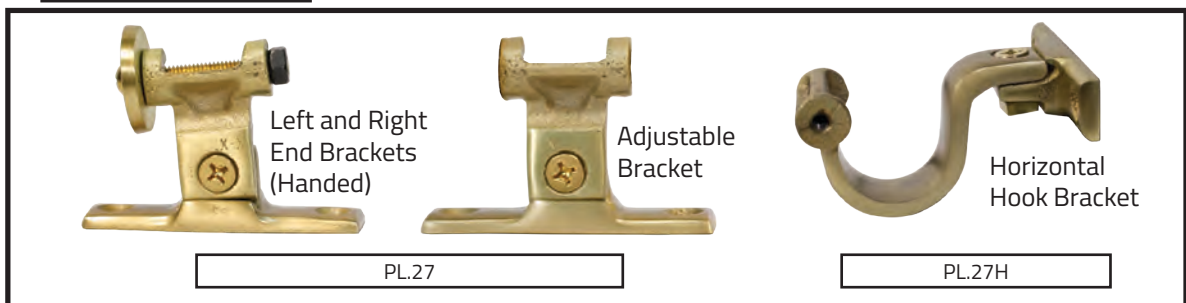

- c. For the Corner Brace/Bracket (PL.40CRVBKT series) used in conjunction with the 90°, 30" radius curved rails (see diagrams below)
- Install the Corner Brace/Bracket by measuring from the inside corner of the 90-degree trim boards out 23 1/4" for both sides.
 - Attach the brace to the shelving unit at the desired height from the floor.
 - Remove the top piece on the horizontal rail bracket that is attached to the Corner Brace.
 - On the curved rail, mark the halfway point on the rail, this is where the horizontal bracket on the corner brace will be located.
 - On the trim, measure from the inside corner out approximately 42" on both sides, this will be the location of the two additional rail brackets.
 - Follow Steps 3a or 3b above to install these additional rail brackets.
 - Reattach the center rail bracket and add two additional brackets towards each end of the curved rail, secure these brackets to the shelving unit.
 - Additional rails can then be added to the curved rail as needed by using the wooden dowel to connect them.

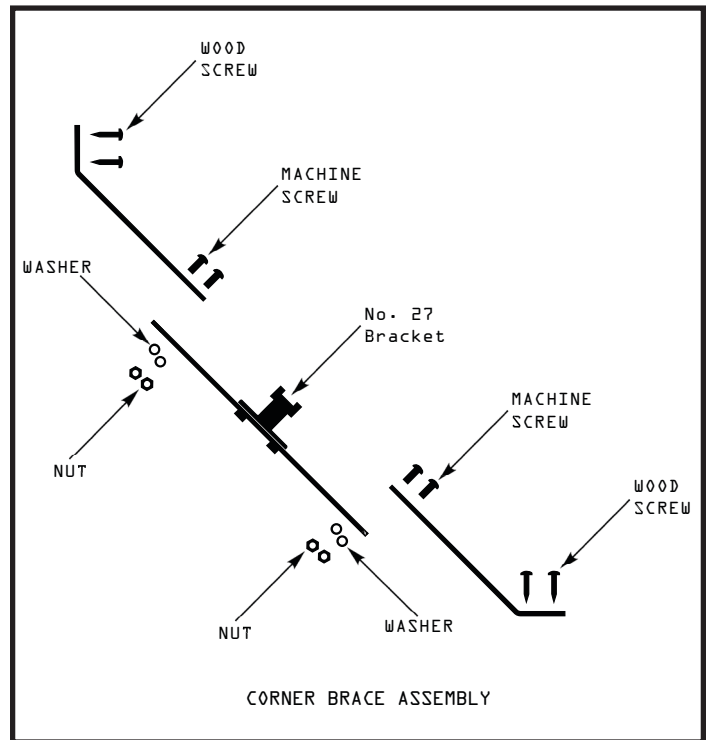
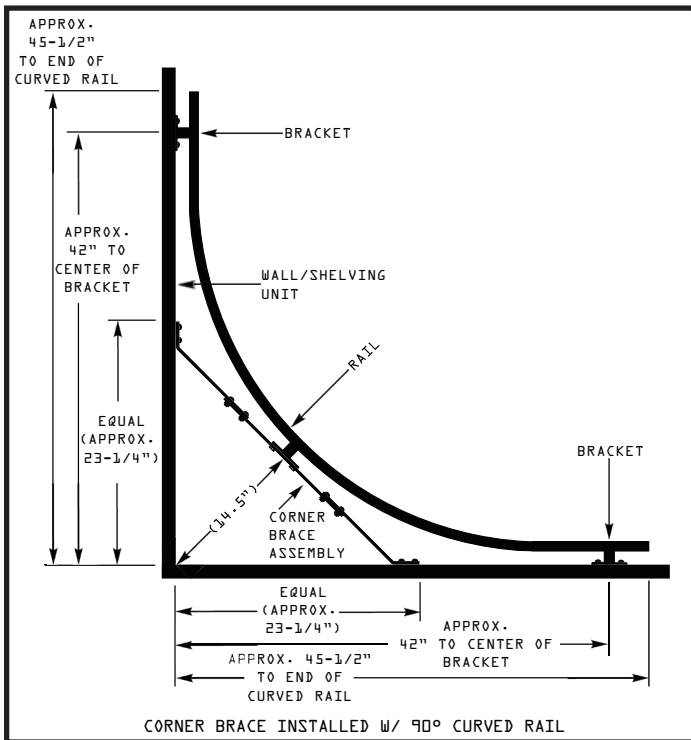

Step 2: Ladder Assembly (if applicable)

It is recommended that the unfinished ladder rail sides and steps are lightly hand sanded with a 220 grit sanding pad just prior to finishing the ladder (stain, paint, clear coat sealer).

It is also much easier to finish the ladder prior to assembly.

1. Stand on edge one of the ladder side rails on a flat surface, dados facing away from you.
2. Insert one of the steps into the dado, aligning the compound miter of the step flush with the dadoed surface of the side rail. If not flush, flip and/or rotate the step until it lines up properly with the side rail (see the following page).

Incorrect

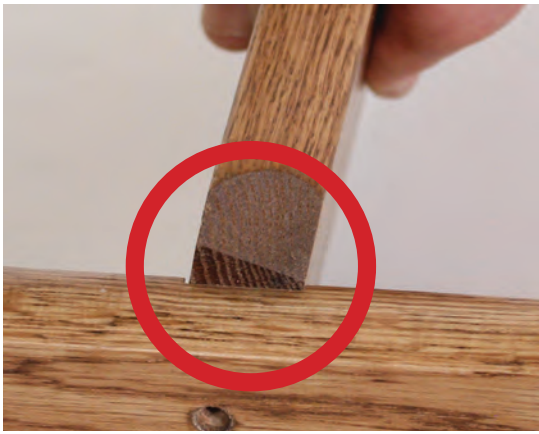

Correct

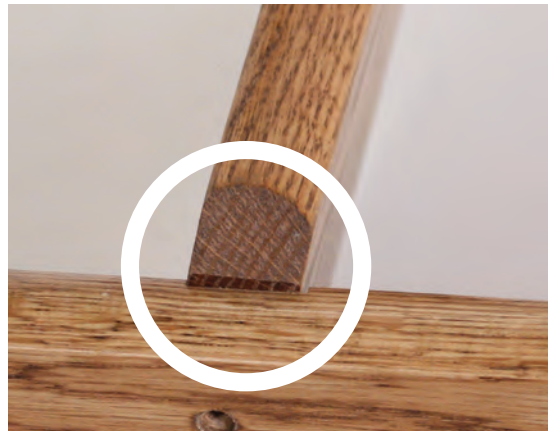

3. Using the supplied #14 x 2½" round-head screws, secure the step to the side rail through the predrilled holes on the side rails. Assemble the remaining steps in the same manner (*see figure 3a*).
4. Once all the steps are assembled onto one of the side rails, position the side rail on its side with the steps pointing up and insert the top turned rung (*see figure 3b*).
5. Properly align each step as well as the top turned rail into its corresponding dado/ hole, use the supplied screws to fasten the steps into place (*see figure 3c*).

Figure 3a



Figure 3b



Figure 3c



6. Install the Truss Rods
 - a. Drive in the threaded insert using a rubber mallet (*see figure 4*).
 - b. Slide the threaded rod through the hole in the ladder side rail and tighten with a ⅜" socket or open-end wrench.

Figure 4a



Figure 4b



Figure 4c



Step 3: Attaching the Hardware to the Ladder

1. Install the upper roller and hook assemblies (Straight Side Rails).
 - a. Center the upper assembly around the top turned dowel. Measure down from the top of the ladder to the top of the Upper Assembly hardware (approx. $1\frac{1}{2}$ "). This measurement should be the same on both wood side rails (see figure 5).

Figure 5a

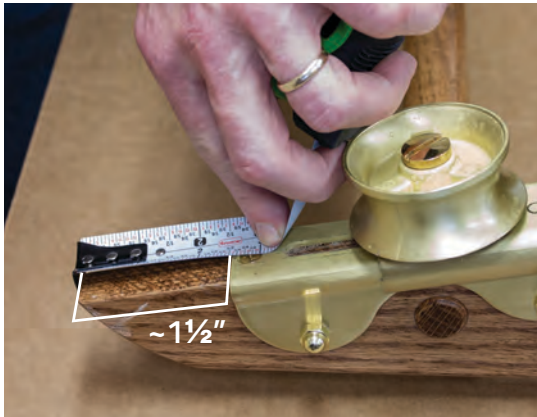
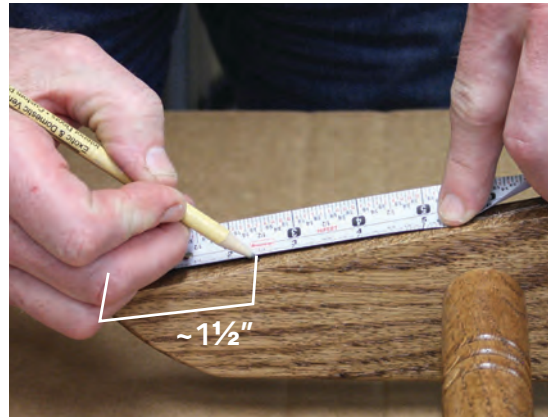
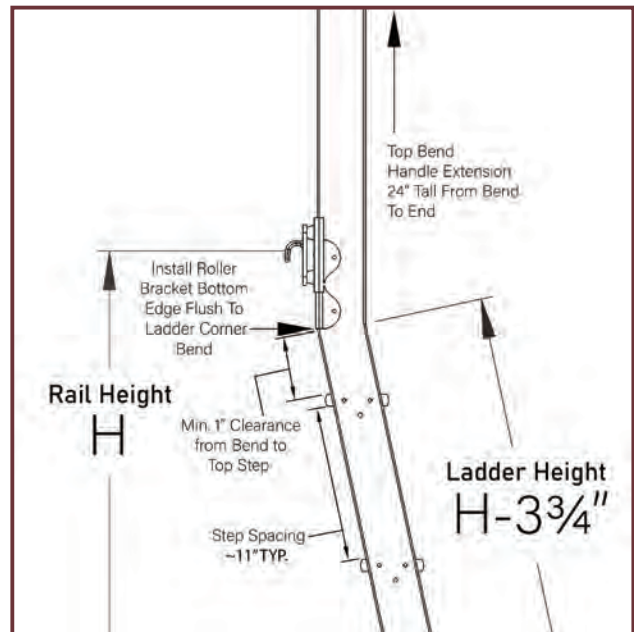

Figure 5b



2. Install the upper roller and hook assemblies (Top Bent Side Rails).
 - a. See diagram for location of the upper assembly hardware.

1. Using a Vix bit or similar self-centering drill guide, drill a pilot hole into the edge of the ladder for the (2) #10 x $\frac{3}{4}$ " Flat-head, Phillips-drive screws and secure each Upper Assembly to the top of the ladder (see figure 6).



PLEASE NOTE: *Pre-drilling is essential to prevent splitting the wood.*

Figure 6a



Figure 6b



Figure 6c



2. Using a ¼" drill bit, drill out the through holes for the ¼-20 Phillips, pan-head 1 ⅜" long bolts. We recommend this procedure:
 - Using the holes in the upper assembly as a drill guide, drill a ¼" hole halfway through the thickness of the ladder slide rail.
 - Drill the same hole on the opposite side of the Upper Assembly, producing a straight ¼" through hole in the ladder side rail.
 - Follow this same procedure for all 4 through holes and finish by securing the upper assemblies with the supplied ¼-20 Phillips drive, pan-head bolts and acorn nuts.

Note: For the PL.210 series Upper Roller Assembly, the larger diameter wheel is on the top (see figure 7).

Figure 7a



Figure 7b

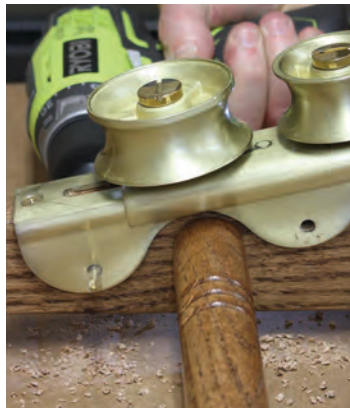
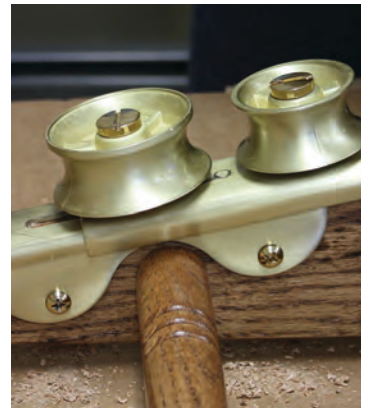

Figure 7c



Figure 7d



2. Install the bottom wheel assemblies

- a. Place the bottom wheel assembly onto the bottom of the ladder using the "U" bracket portion of the housing. Verify that the bracket is flush with the bottom of the ladder. (Because of the 12-degree angle of the bottom of the ladder, this will align the housing diagonally across the ladder side rail).



- b. Mark the location of the "U" bracket on the bottom of the ladder, this will be approximately 2" in from the front of the rail. At the same time, mark the location on the side of the ladder for the top and middle mounting holes of the bottom wheel assembly. Measure these marks and transfer these measurements to the other ladder side rail so that the hardware will mount identically on both ladder side rails (see figure 8).
- c. Using a ¼" drill bit, drill through holes in the ladder side rail for the ¼-20 pan-head bolts (see figure 8).

Figure 8a



Figure 8b



Figure 8c



Figure 8d



- d. Pre-drill the ladder side rail for the #10 Flat-head, Phillips drive $\frac{3}{4}$ " screw (see figure 9). **PLEASE NOTE: Pre-drilling is essential to prevent splitting the wood.**
- e. Install the bottom wheel assemblies using the included screws, bolts, and acorn nuts.

Figure 9a

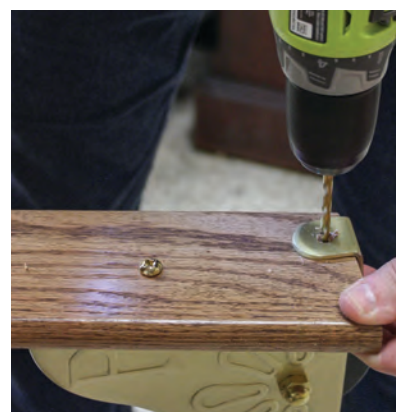

Figure 9b



Figure 9c



...and your Putnam Ladder is complete!

Putnam Ladder Application Images



Hardware Dimensions

Bottom Wheel Measurements

- Length - 6 $\frac{1}{8}$ "
- Width - 2 $\frac{1}{4}$ "
- Height - 8 $\frac{1}{8}$ "

PL.270-C

Bottom Wheel Measurements

- Length - 6 $\frac{3}{16}$ "
- Width - 2 $\frac{1}{2}$ "
- Height - 8 $\frac{1}{4}$ "

PL.270-S

Upper Wheel Measurements

- Length - 3 $\frac{1}{4}$ "
- Width - 1 $\frac{3}{4}$ "
- Height - 6"

PL.210

Upper Hook Measurements

- Length - 4"
- Width - 1 $\frac{3}{4}$ "
- Height - 6"

PL.230

Corner Bracket Measurements

- Length - 2 $\frac{1}{4}$ "
- Width - 3 $\frac{3}{8}$ "
- Height - $\frac{3}{4}$ "

PL.40CRVBKT

Hardware Dimensions

Vertical Hook Bracket Measurements

- Length - 1 $\frac{5}{8}$ "
- Width - 1 $\frac{1}{4}$ "
- Height - 3 $\frac{3}{4}$ "

PL.14H

Vertical Bracket Measurements

- Length - 1 $\frac{5}{8}$ "
- Width - 1 $\frac{1}{4}$ "
- Height - 5"

PL.14

Horizontal Hook Bracket Measurements

- Length - 3 $\frac{1}{2}$ "
- Width - 2 $\frac{1}{8}$ "
- Height - 3 $\frac{1}{2}$ "

PL.27H

Horizontal Bracket Measurements

- Length - 2 $\frac{1}{4}$ "
- Width - 3 $\frac{3}{8}$ "
- Height - $\frac{3}{4}$ "

PL.27

Truss Rod

- $\frac{1}{4}$ -20 Partially Threaded Rod, 15.875" long
- Hex Head with Flat to Flat $\frac{3}{8}$ " wide, $\frac{1}{4}$ " Dia. Shaft
- Last $\frac{7}{8}$ " of bolt threaded

Nut

- $\frac{1}{4}$ -20 x $\frac{1}{2}$ " Propel nut

Washer

- $\frac{1}{4}$ " x $\frac{5}{8}$ " Dia. Flat Washer

15.875"

Also available from CSH:



Mini Barn Door Hardware



Rolling Barn Door Hardware



Inswing



Closed position



Outswing

InvisiDoor



📍 1170 Wauwatosa Rd.
Cedarburg, WI 53012

☎ (262) 365-7960

🌐 cshardware.com